

Instruction Manual



REPUBLIC ARMS
R.A.P. 401

THIS HANDBOOK
IS IMPORTANT
DO NOT DISCARD



REPUBLIC ARMS (PTY) LTD

PRIVATE BAG 33346
JEPPESTOWN 2043

REPUBLIC OF SOUTH AFRICA

TEL: (011) 814-1619 FAX (011) 614-8137

PART No. 401/06/02

TABLE OF CONTENTS

DESCRIPTION	PAGE
TABLE OF CONTENTS	2
GENERAL	3
TECHNICAL DATA	3
OPTIONAL ACCESSORIES	3
NOMENCLATURE	4
SAFETY PRECAUTIONS	5
SAFETY DEVICES	6
AMMUNITION	7
THE MAGAZINE	7
LOADING THE PISTOL	8
AIMING THE PISTOL	10
FIRING THE PISTOL	11
SAFETY OPTIONS	12
DISMANTLING THE PISTOL	13
SLIDE ASSEMBLY	13
RECOIL SPRING ASSEMBLY	14
BARREL	15
REASSEMBLING THE WEAPON	16
CLEANING AND LUBRICATION	17
PARTS LIST	19

GENERAL

TECHNICAL DATA

Calibre	9 x 19 Parabellum	.40 S&W
Overall Length	165 mm	165 mm
Height	120 mm	120 mm
Width	32 mm	32 mm
Barrel Length	89 mm	89 mm
Weight Empty	815 gm	815 gm
Weight Loaded	1010 gm	1010 gm
Magazine Capacity	8	7

OPTIONAL ACCESSORIES

- Cleaning Kit
- Spare Magazine
- Magazine Extension

Page 3

NOMENCLATURE

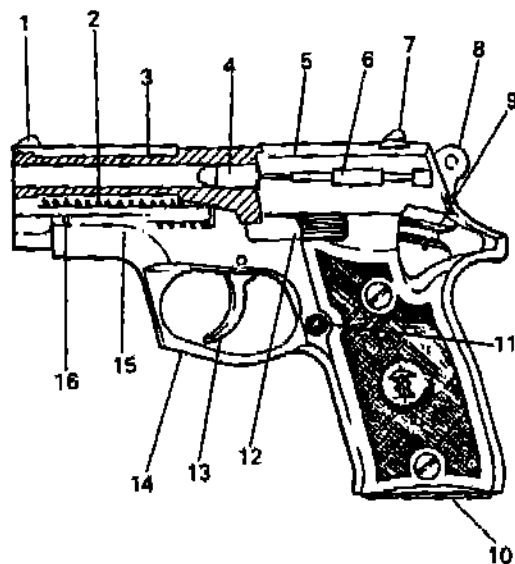

1. Front Sight
2. Recoil Spring
3. Barrel
4. Cartridge in Chamber
5. Slide
6. Firing Pin
7. Rear Sight
8. Hammer
9. Safety/De-cocking Lever
10. Magazine
11. Magazine Release Button
12. Slide Stop
13. Trigger
14. Trigger Guard
15. Frame
16. Reference Mark for Dismantling

Page 4

SAFETY PRECAUTIONS

CAUTION

BEFORE HANDLING ANY WEAPON, READ THE INSTRUCTION MANUAL TO FAMILIARISE YOURSELF WITH ITS FUNCTIONS AND SAFE HANDLING PROCEDURES.

When handled properly the RAP 401 is one of the safest handguns available, but never forget that even the safest weapon is dangerous when not handled in the correct manner.

Safety Rules

Always check for live ammunition before handling the weapon, particularly when giving it to or receiving it from another person.

When circumstances allow, Hearing Protection and Safety Glasses must be worn.

Never point the weapon at anything that you do not intend to shoot.

Do not insert your finger into the trigger guard until you are ready to fire.

When handling the pistol ensure that it is never pointing at any part of yourself or any other person.

Keep the pistol in a safe place out of the reach of children.

Never fire a bullet at any hard surface or water.

Before firing ensure that the barrel is free of all obstructions. Any obstructions in the barrel such as mud, sand, cleaning materials or a heavy deposit of grease may result in a bulged or burst barrel. If a weak report is heard while firing, inspect the barrel for a blockage.

Unload the pistol when it is stored and keep the ammunition in a separate place.

The pistol is still capable of being fired with the magazine removed. Always inspect the chamber and ensure that it is clear of any ammunition.

Page 5

SAFETY DEVICES

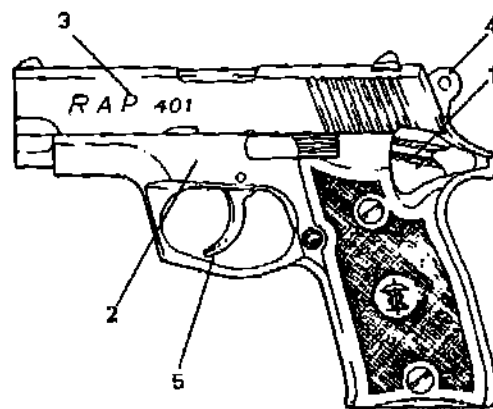

MANUAL SAFETY

With the weapon pointing forwards, the Safety/De-cocking Lever (1) is located on the left rear of the Frame (2) and is engaged by pushing the lever upwards until it covers the red dot.

In this position the manual safety locks the Slide (3) and the Hammer (4) and disconnects the Trigger (5).

The safety can be engaged with the Hammer (4) cocked or uncocked.

HALF COCK

The Half Cock notch prevents the Hammer (4) from striking the firing pin if your thumb should slip while cocking the Hammer.

AUTOMATIC FIRING PIN SAFETY

The Automatic firing pin safety blocks the firing Pin and is only disengaged when the Trigger (5) is pulled.

SAFETY/DE-COCKING LEVER

Moving the Safety/De-cocking Lever (1) downwards, lowers the Hammer (4) safely.

Page 6

LOADING THE PISTOL

AMMUNITION

The RAP 401 pistol is manufactured in 9x19 mm Parabellum calibre and .40 S&W calibre.

These are two different calibres and the ammunition is NOT interchangeable.

The calibre of your weapon is marked on the right hand side of the barrel which is visible through the cut out portion of the slide. Use only ammunition which corresponds with the calibre marked on your weapon's barrel.

The ammunition calibre is stamped on the base of the Cartridge Case.

Always use ammunition manufactured by a reputable factory, reloaded ammunition is not recommended.

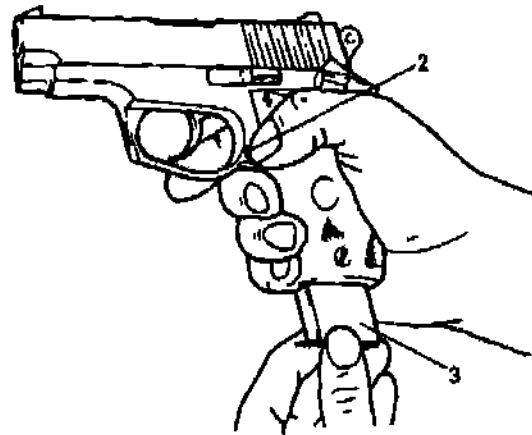
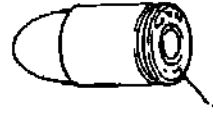

REMOVING THE MAGAZINE

Depress the Magazine Release button (2) with the thumb and withdraw the Magazine (3) from the base of the grip.

Page 7

FILLING THE MAGAZINE

Hold the Magazine (1) in one hand and the Cartridge between the thumb and index finger of the other.

Depress the front edge of the Magazine Follower (2) with the Cartridge Rim and then slide the Cartridge under the lips of the Magazine.

The second Cartridge is pressed against the first and the cycle is repeated until the required number of Cartridges are inserted.

The number of cartridges inserted can be seen through the holes (3) in the side of the Magazine.

Maximum Magazine capacity is 8 (eight) rounds for 9 mm PB, 7 (seven) rounds for .40 S&W

EMPTYING THE MAGAZINE

Push each Cartridge forward until it is no longer held by the magazine lips.

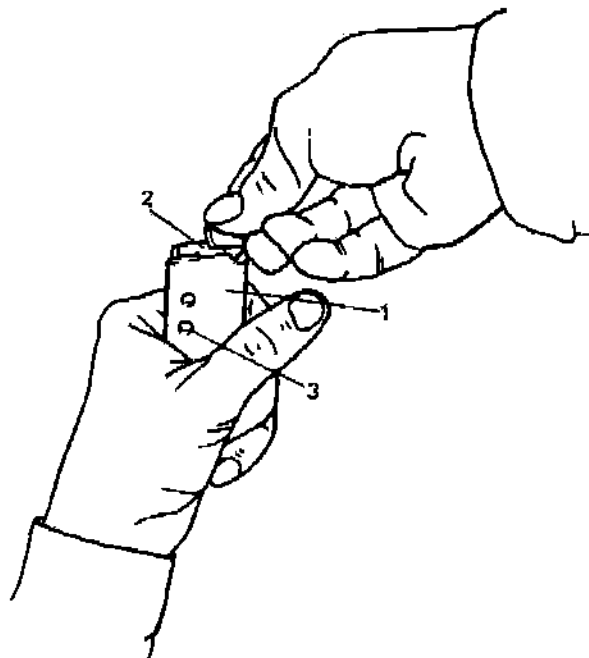

Page 8

LOADING THE PISTOL

Hold the Pistol in your shooting hand, taking care to keep your finger away from the Trigger.

Slide the loaded Magazine (1) into its housing in the Hand Grip until it engages the Magazine Release Button (2).

CHAMBERING THE FIRST ROUND.

Grip the Slide (3), by the serrations, with your free hand, pull it completely back, and then release it smartly.

The action of the Recoil Spring will cause the Slide to snap forward, strip the top Cartridge from the Magazine and chamber it.

CAUTION
THE PISTOL IS NOW LOADED, COCKED
AND READY TO FIRE.

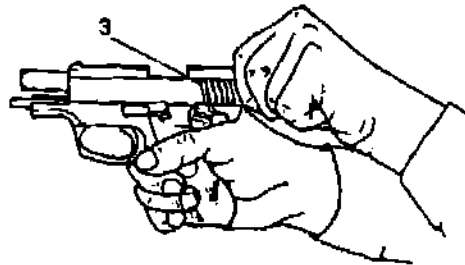
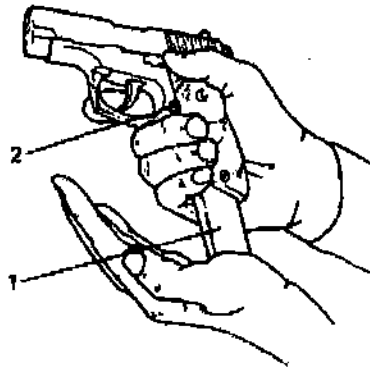

Page 9

AIMING THE PISTOL

The Pistol is aimed by aligning the Front (1) and Rear (2) sights with the target. The Aiming Point (3) should appear just above the sights, it should not be obscured by them.

The correct sight picture will vary according to the target distance, the type of ammunition used and the shooter's technique.

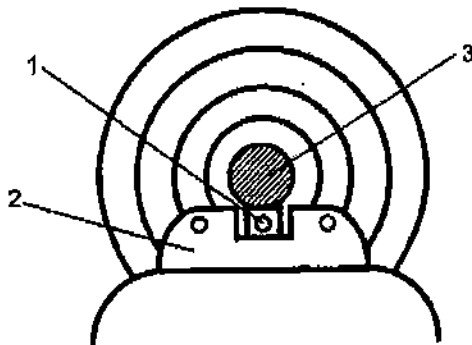

Page 10

FIRING THE PISTOL

The Pistol is fired by pulling the Trigger (1) with the index finger of the shooting hand.

When the Pistol is fired the Slide (2) will reciprocate and automatically eject the spent Cartridge and chamber a new round.

The Trigger must be released after each shot and pulled again to fire the next round.

When the last round has been fired the Slide will remain in its rearmost position.

To continue firing, remove the empty Magazine, replace it with a loaded one and press the Slide Stop (3) downwards, this will cause the Slide to snap forward, strip the top Cartridge from the Magazine and chamber it.

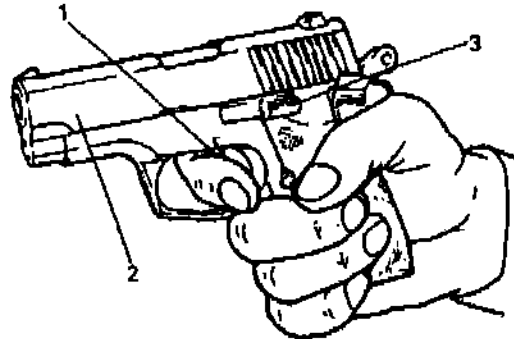

CAUTION

THE PISTOL IS NOW LOADED, COCKED AND READY TO FIRE.

Page 11

SAFETY OPTIONS

If the Pistol is not going to be fired directly after loading the following safety options are available:

1. The full Magazine is loaded into the Pistol, but the Slide is not cycled to feed a Cartridge into the Chamber.
2. The Slide is cycled to feed a Cartridge into the Chamber, DO NOT TOUCH THE TRIGGER, and the Hammer is lowered by moving the Safety De-cocking Lever downwards. The Pistol can be fired in the double action mode by pulling the Trigger. The double action Trigger pull is heavier than when the Hammer is Cocked.
3. Engage the Manual Safety by pushing the Safety/De-cocking lever up until it covers the red dot, this locks the Slide and Hammer and disconnects the Trigger. The Manual safety can be engaged with the Hammer cocked or in its lowered position.

The Firing Pin safety automatically blocks the Firing Pin and is disengaged when the Trigger is pulled.

WARNING

The De-cocking lever should always be used to lower the hammer from the cocked position. Since the Trigger is NOT touched during this operation, the automatic safety blocks the Firing Pin and the Hammer is lowered to the intercept notch (half cock)

NO NOT thumb the Hammer down : if the Hammer slips while the Trigger is being pressed, the consequences can be serious injury or death.

Page 12

DISMANTLING THE PISTOL

SLIDE ASSEMBLY

Remove the Magazine and ensure that the Chamber is unloaded.

Cock the Hammer by hand.

Hold the Pistol in your Right hand and push the Slide (1) with your other hand until the front face of the Slide aligns with the Reference Mark (2) on the left side of the Frame (3).

Hold the Slide in this position.

Press the end of the Slide Stop (4), on the right side of the frame, until it is flush with the frame.

Withdraw the Slide Stop from the left side of the Frame.

Remove the Slide Assembly (1) from the frame by sliding it forward.

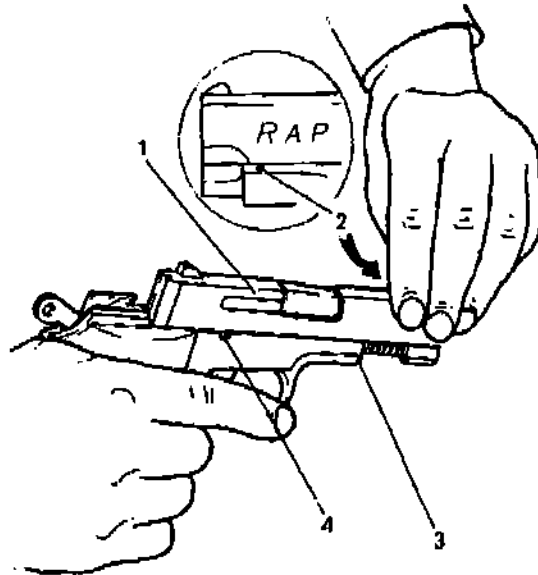

CAUTION

Never allow the Hammer to snap forward after the Slide has been removed as this can damage the Weapon.

Page 13

RECOIL SPRING ASSEMBLY

Pull the rear of the Recoil Spring Assembly (1) slightly forward to disengage it from the Barrel Lug (2).

The Spring is under tension and care must be taken to ensure that it does not spring loose.

Remove the Spring and Spring Guide from the Slide (3) by lifting them upwards and towards the rear of the Slide.

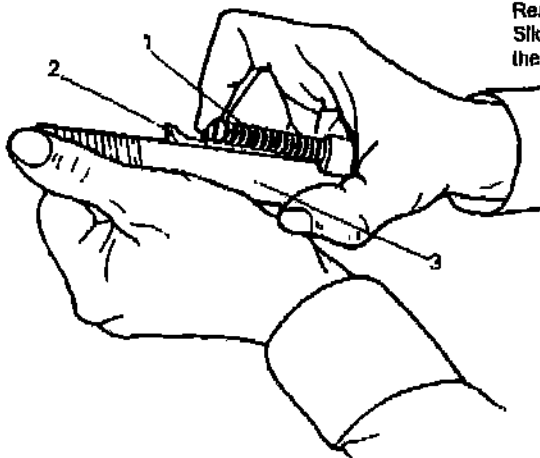

Page 14

BARREL

Remove the Barrel (1) from the Slide (2) by lifting the rear of the Barrel and sliding it towards the rear of the Pistol.

NOTE

Any further dismantling should only be undertaken by a qualified gunsmith.

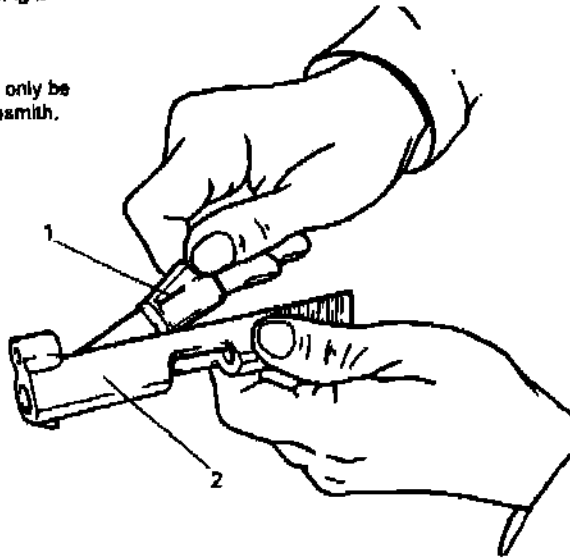

Page 15

REASSEMBLING THE WEAPON

The Reassembly procedures are the reverse of the Disassembly procedures.

CAUTION

When replacing the Slide ensure that the Firing Pin Combblock (1) at the right rear of the Frame (2) does not protrude above the top face of the Frame

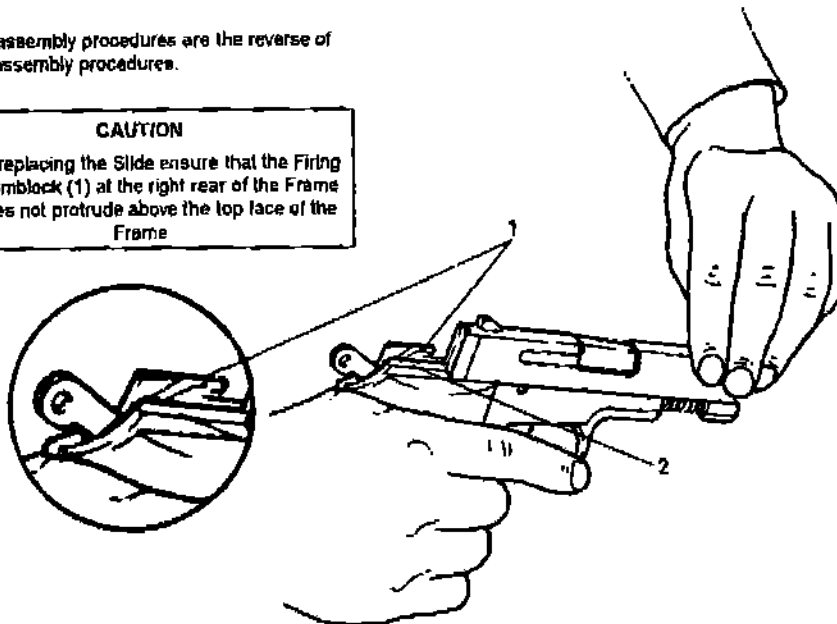

Page 16

CLEANING AND LUBRICATION

After firing, the Barrel Bore and Chamber should always be cleaned with a bronze brush dipped in Nitro Solvent, after which the barrel should be wiped dry and lightly oiled.

All exposed internal surfaces of the frame and slide should be cleaned with Nitro Solvent using a bristle brush or cotton swabs.

All propellant residue (powder) must be removed from the face of the slide in the region of the firing pin and extractor, and from the rear face of the Barrel.

All moving parts should be lightly lubricated with a good quality gun oil.

The exterior metal surfaces of the Pistol should be wiped with a lightly oiled cloth to remove fingerprints and prevent corrosion. In dusty climates the use of a dry Silicon spray designed for Firearm lubrication will be less likely to retain dust or sand.

The Handgrips are manufactured from a durable polymer and require no maintenance.

Page 17

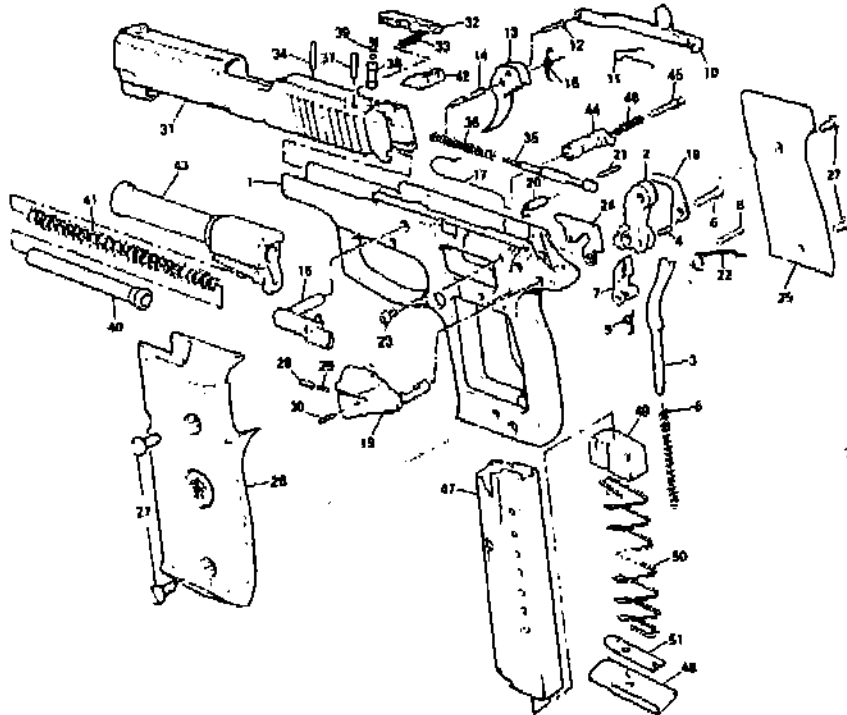

Page 18

CLEANING AND LUBRICATION

After firing, the Barrel Bore and Chamber should always be cleaned with a bronze brush dipped in Nitro Solvent, after which the barrel should be wiped dry and tightly oiled.

All exposed internal surfaces of the frame and slide should be cleaned with Nitro Solvent using a bristle brush or cotton swabs.

All propellant residue (powder) must be removed from the face of the slide in the region of the firing pin and extractor, and from the rear face of the Barrel.

All moving parts should be lightly lubricated with a good quality gun oil.

The exterior metal surfaces of the Pistol should be wiped with a lightly oiled cloth to remove fingerprints and prevent corrosion. In dusty climates the use of a dry Silicon spray designed for Firearm lubrication will be less likely to retain dust or sand.

The Handgrips are manufactured from a durable polymer and require no maintenance.

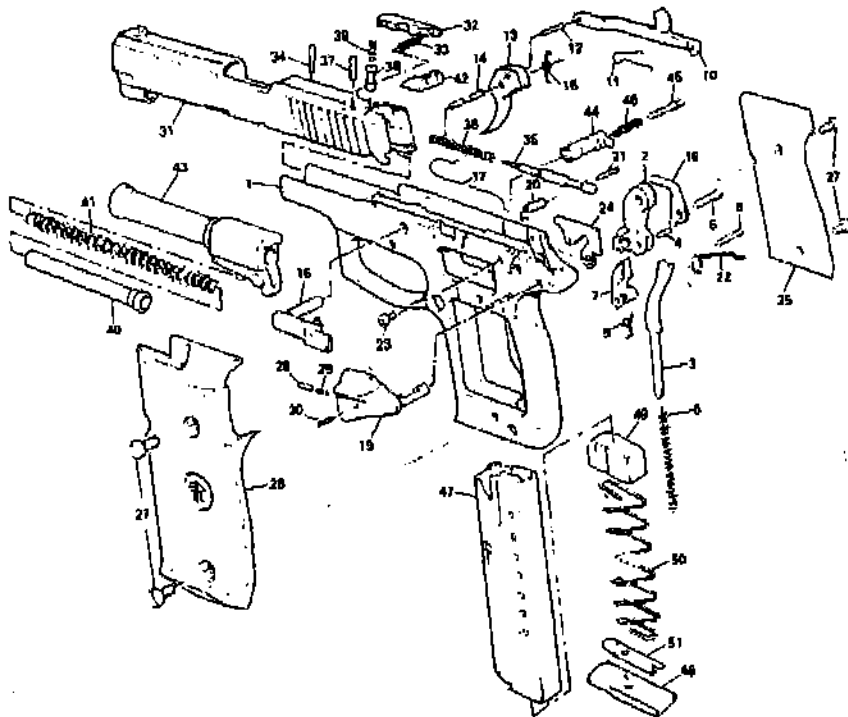

This Manual Was Provided To You By:



**CENTURY
INTERNATIONAL
ARMS INC.**

www.centuryarms.com